



**THOR 4** / **54x1,3**

 mm  
450

 a x b  
450x450

 a x b  
450x300

  
3x400V 50 Hz

  
9,0

  
20-150

  
6830x54x1,3

  
6100

**Lmin**  
3300

**Lmax**  
3630

**B**  
2100

**Hmin**  
2340

**Hmax**  
2590

**V**  
800



THOR 4

STANDARD    OPTION

SIEMENS HMI "9"	TH4-NPH	LED	TH4-HPV	PEGAS-ASR	PEGAS-ARP	PEGAS-RZP
TH4-ARN	TH4-IMB	TH4-RTS-A	TH4-ECK	TH4-CMU2	TH4-OCF	TH4-OCS
TH4-ATB	TH4-KKR	TH4-ABP	TH4-BSB	TH4-BSF	TH4-FCV	CDC
TH4-BGT	PCP	BLUEBOX	TH4-HP-A	MINI LUBE 54	SPR-LUBE	SYNC-1

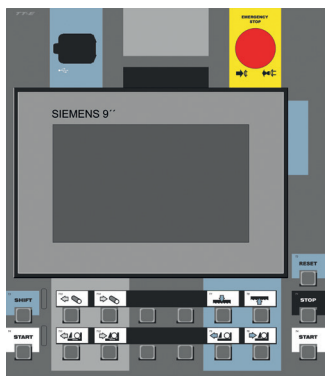
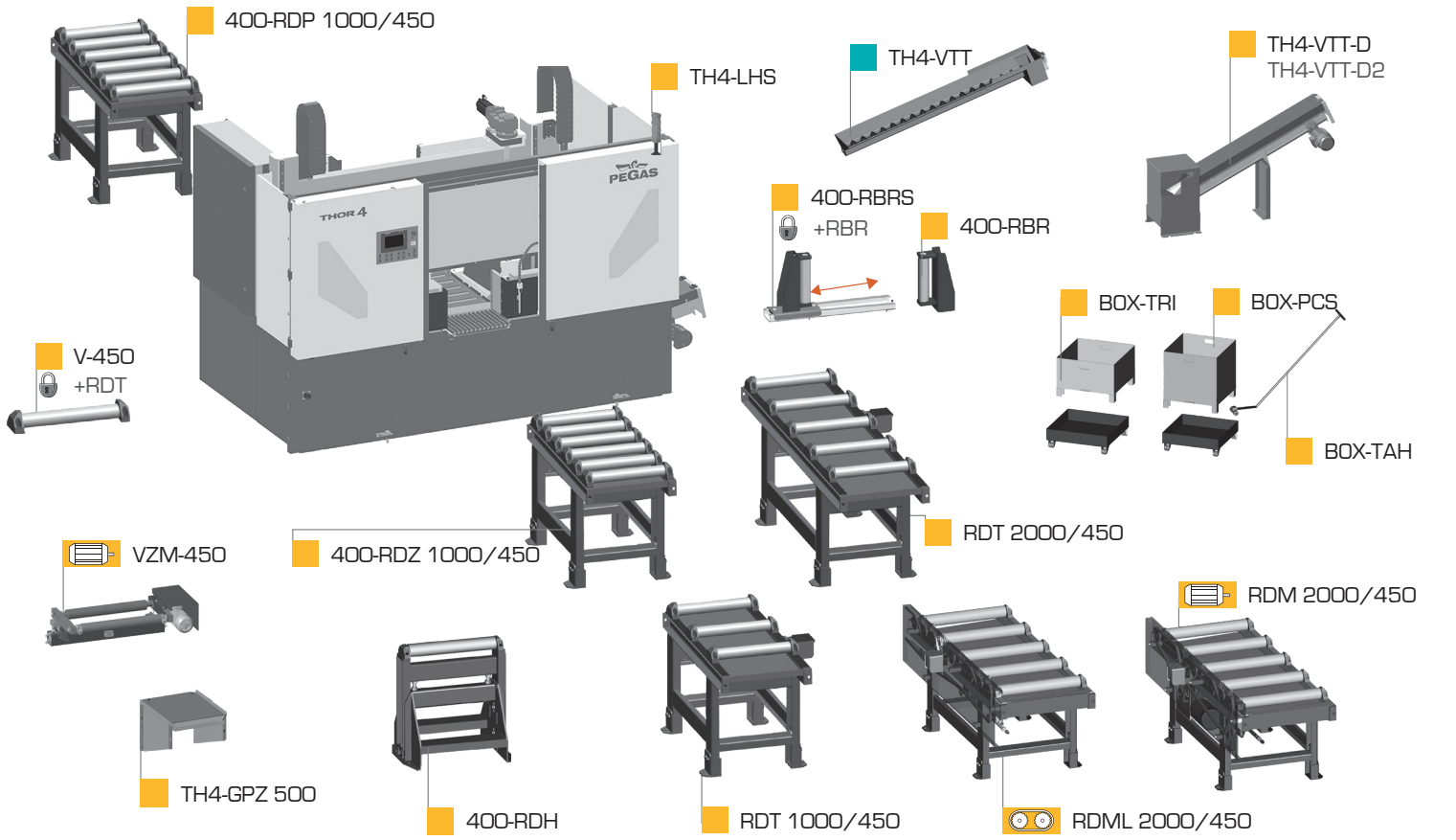

CONTROL PANEL: SIEMENS (X-CNC)

## THOR 4

- výrobce si vyhrazuje právo provádět změny technických údajů, technické údaje odpovídají 1.1.2023 / producer has the right to make changes of technical data, technical data are valid on 1.1.2023

- pila na fotografii není vždy v základním provedení, uvedené rozměry odpovídají stroji v základním provedení / the machine in the picture is not always in the basic version, mentioned diameters are for machine in basic version

\* doporučená hodnota. Při překročení doporučeného maximálního průměru není možné garantovat výkon pilového pásu! / recommended value. The blade performance cannot be guaranteed when the recommended diameter is exceeded!

☒ - řezání svazků bez horního přitlačku / cutting of the bundle without top clamping



PEGAS - GONDA s.r.o.  
Čs.armády 322, 684 01 Slavkov u Brna,  
CZECH REPUBLIC

[www.pegas-gonda.cz](http://www.pegas-gonda.cz)  
00420-544 221 125 (126) | [pegas@gonda.cz](mailto:pegas@gonda.cz)